

FORT TROFF ISSUED HAMMOCK HANGAR SLING

ASSEMBLY and USAGE INSTRUCTIONS

INS-1105-01

Structure Components

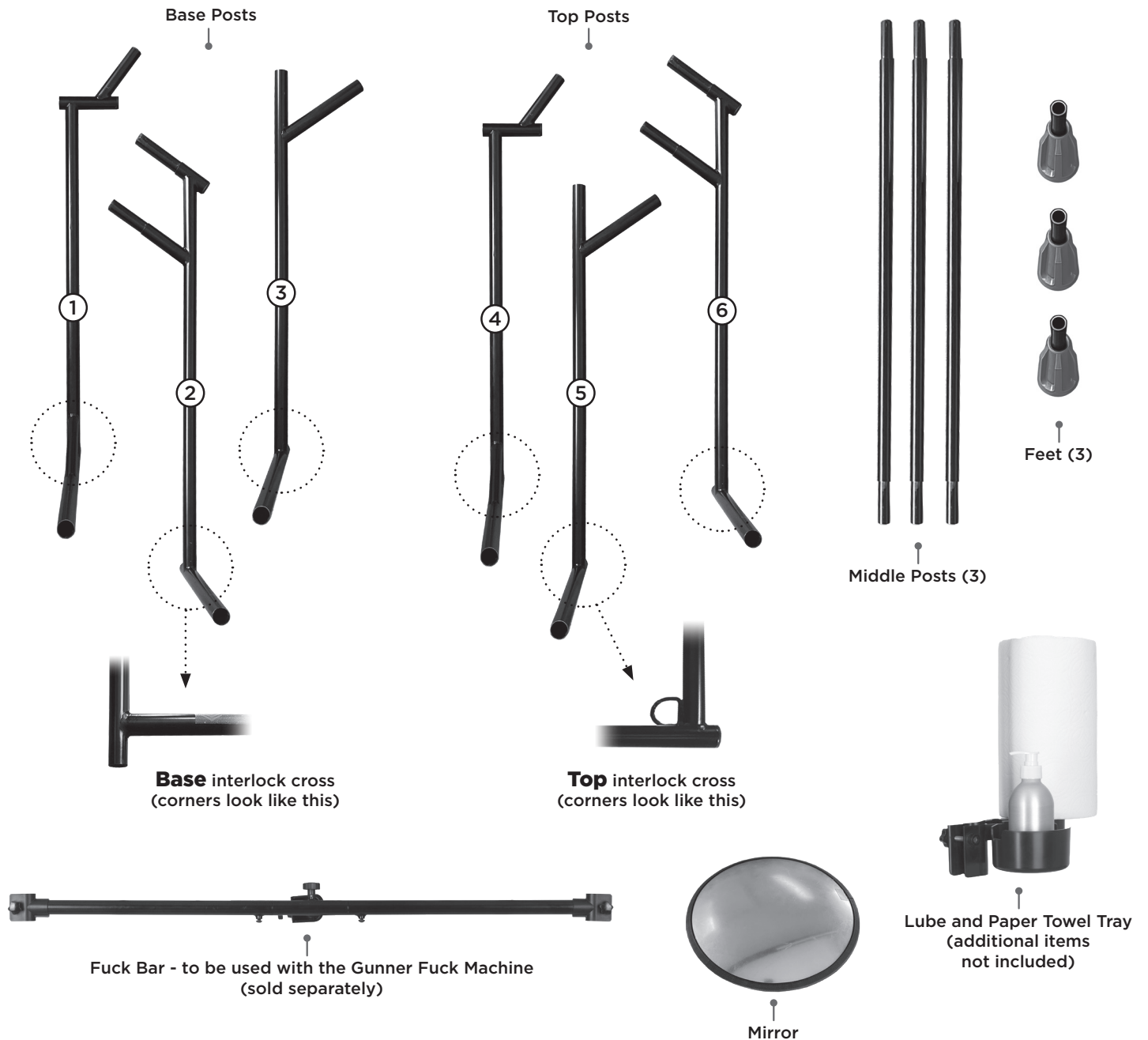

Assembling the Structure

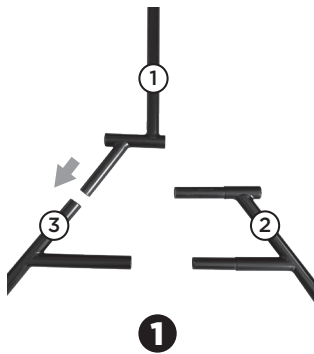

1
Match all 3 bottom interlocks, numbers 1 to 3 with their corresponding numbers as shown.

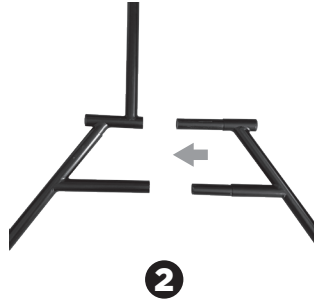

2
Slide the two left and right interlocks as shown by the arrow.



3
Slide the two half together as shown by arrows. Make sure it is all the way inserted.

Repeat these 3 steps for the top interlock bars labeled 4, 5 and 6.

4
Slide in all 3 middle posts into the BOTTOM (the one with the logo stickers) interlock cross as shown.

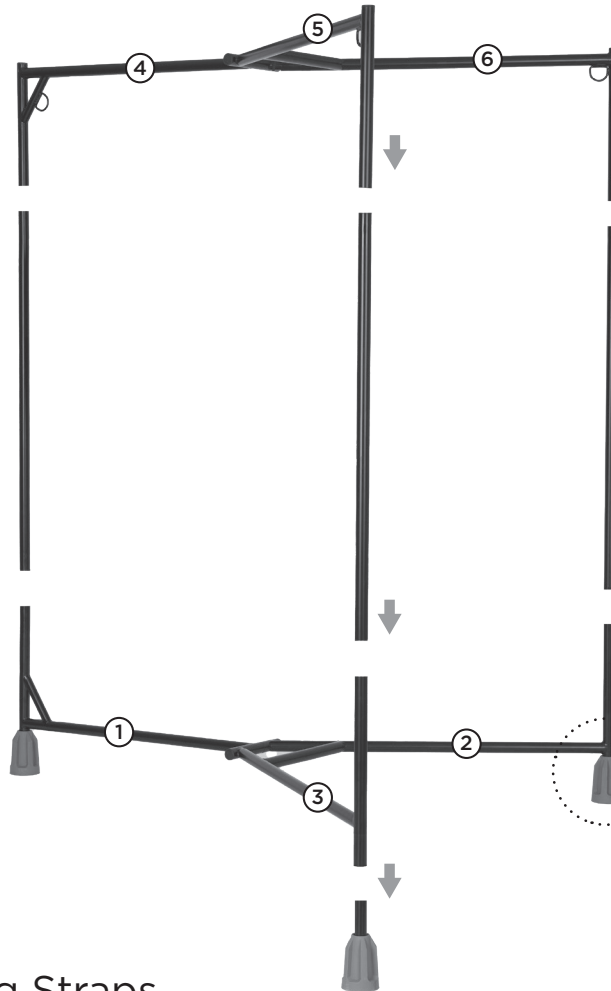

5
Install TOP (the one with the O rings) interlock X by sliding it onto the 3 middle posts.

NOTE: For safety and ease of assembly, it is suggested doing this with at least two persons.

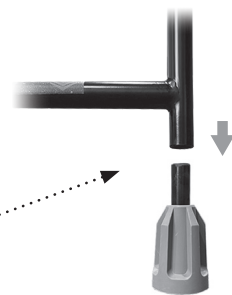

6
Finally, install the feet as shown.

Attaching the Leg Straps



1
To attach the leg-holding straps, wrap each around the hardware at the Sling's horizontal top bar, as shown.



2
Secure the straps by connecting each velcro end, pressing tightly together.



3
Insert the leg-holding strap into the hardware, as shown. Adjust height as desired.

Installing the Fuck Bar

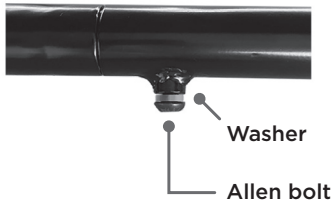

1

Attach both side arms to the center pole and tighten the bolts with the washers installed using the provided Allen key to tighten it. Please refer to the illustration for details.

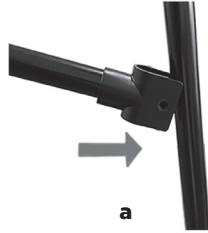

a

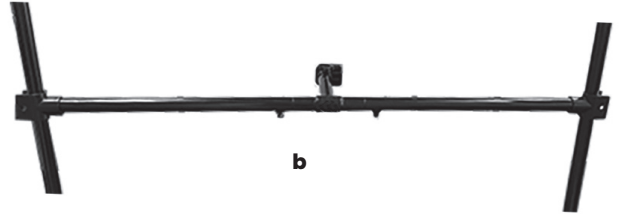

b

2

Slide in the Fuck Machine attachment to the left or right pole as shown (a), and repeat at the other end. Adjust height and make the bar level (b), and tighten the knob (c).

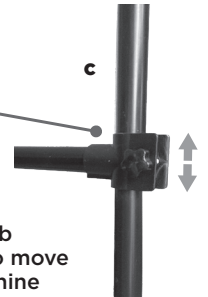

c

3

Install the Fuck Machine by screwing Knob (D) through the attachment and into the machine as shown below. Adjust at will using all the other knobs. (Fuck Machine Sold Separately)

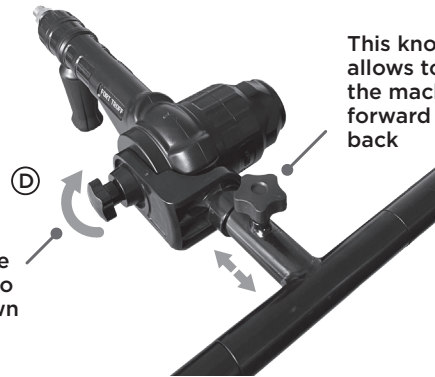

(D)

This knob secures the machine to the bar and allows it to rotate up and down

This knob allows to move the machine forward or back

Installing the Mirror



Holder

Holder

1

Rotate the two Holders to align them with the Interlock arms. They should be parallel to each other.

Please note: Depending on which Sling model you bought, the interlock may be different. Please rotate the Holders accordingly.



2

Snap the Holders to the Interlock as shown.

Please note that while your interlock may differ in design, the Mirror snaps to it in the same fashion.

Top view from above structure



3

Peel off the protective film.

Cup removal: press the back tab to allow the cup's release.

Installing the Tray

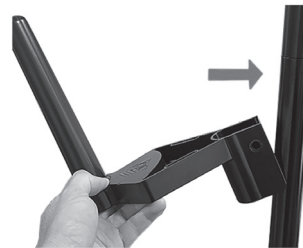

1

Screw the paper towel rod in place tightly.

2

Snap the tray to your preferred post as shown.



Tightening Knob

3

Tighten up using the screw.

4

Snap on the cup.

Please be sure it "clicks". The tray is now ready to use.



Hammock Components



Assembly

Please pay attention to the hammock orientation. It is not symmetrical as the head and butt pillows use different Velcro attachments.



Head pillow presses onto the hammock's velcro.

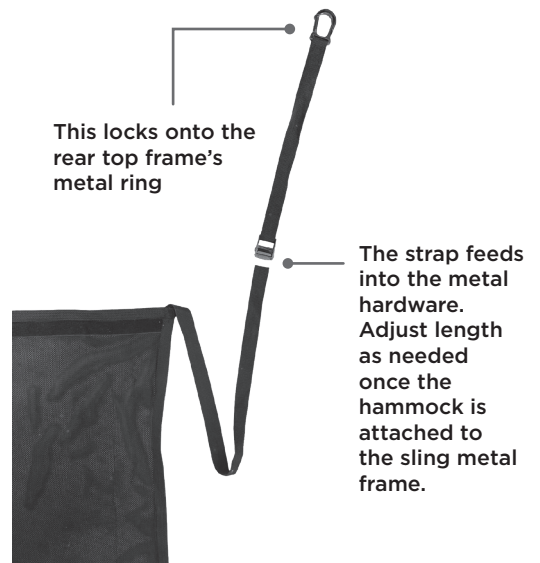

for product information scan code or go to docjohnson.com/forttroff

EU Authorised Representative (for authorities only)
ProductIP AR Services Galvanistraat 1, 6716 AE Ede, The Netherlands

UK Authorised Representative (for authorities only)
ProductIP (UK) Ltd. 8, Northumberland Av., London WC2N 5BY